

Wind Energy Multipole connectors



The Company and the Product

I.L.M.E. SpA - INDUSTRIA LOMBARDA MATERIALE ELETTRICO - has been operating in Milan since 1938, in particular in the electrotechnical sector for the manufacturing of equipment for industrial installations.

ILME reflects the traditional entrepreneurial spirit of Lombardy, and has enjoyed continuous expansion for over half a century. The company has carved an important role for itself in the main world markets, also operating directly in the countries that have assumed world leadership in the field of automation, including Germany and Japan. In the electrical connection sector with applications in industrial automation, characterised by top performance and utmost reliability

needs, ILME is today the acknowledged partner of many leading companies worldwide.

The company's fundamental values are: product innovation, original solutions, excellent price-quality ratio, a customer-oriented sense of service, ethical behaviour and an environmentally-friendly approach. To promote the continuing improvement of its qualitative results, ILME has always encouraged its collaborators to work with utmost responsibility and participation. The company focuses on a series of benefits to the user, including research into the most suitable materials, high quality and safe cabling, a rapid turnaround and readily available services.



Certification ISO 9001: 2008
Design, manufacture and distribution of industrial electrical equipment (IAF 19, 29a)
Certificate N° 50 100 11133



Overview of the products in wind turbines

- ① Pitch control system
- ② Slip ring
- ③ Control cabinet
- ④ Generator cables
- ⑤ Signal light / Anemometer
- ⑥ Interior lighting systems
- ⑦ Brakes
- ⑧ Elevators
- ⑨ Yaw motor / Gear
- ⑩ Data transmission

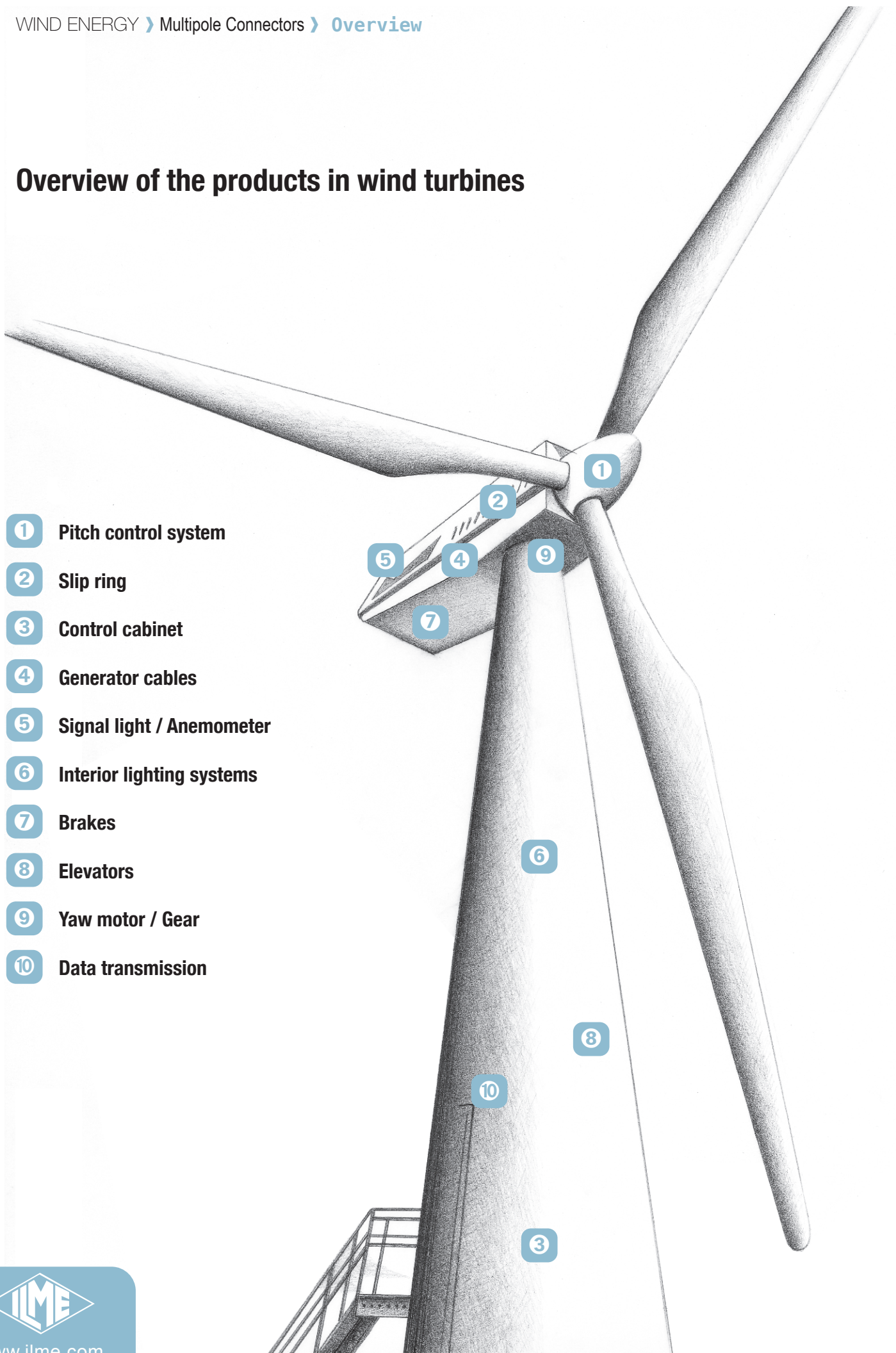

Overview of the connectors

ANCHORS



Internal use for electrical panels

COB

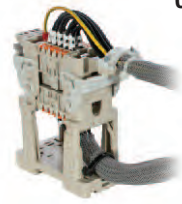

Internal installation for electrical panels or DIN rail

RJ45 Connectors



Ethernet Category 5 and Category 6A

DOCKING FRAME



Self-centering connections

CLK 04 SC



Fibre optic SC contacts

CX 1/2 BD Insert adaptor



Round shielded connectors

Pitch control system

Slip ring

Signal light / Anemometer

Interior lighting systems

BIG



Large and modular enclosures up to 7 holes

IP68



Up to IP68 degree of protection

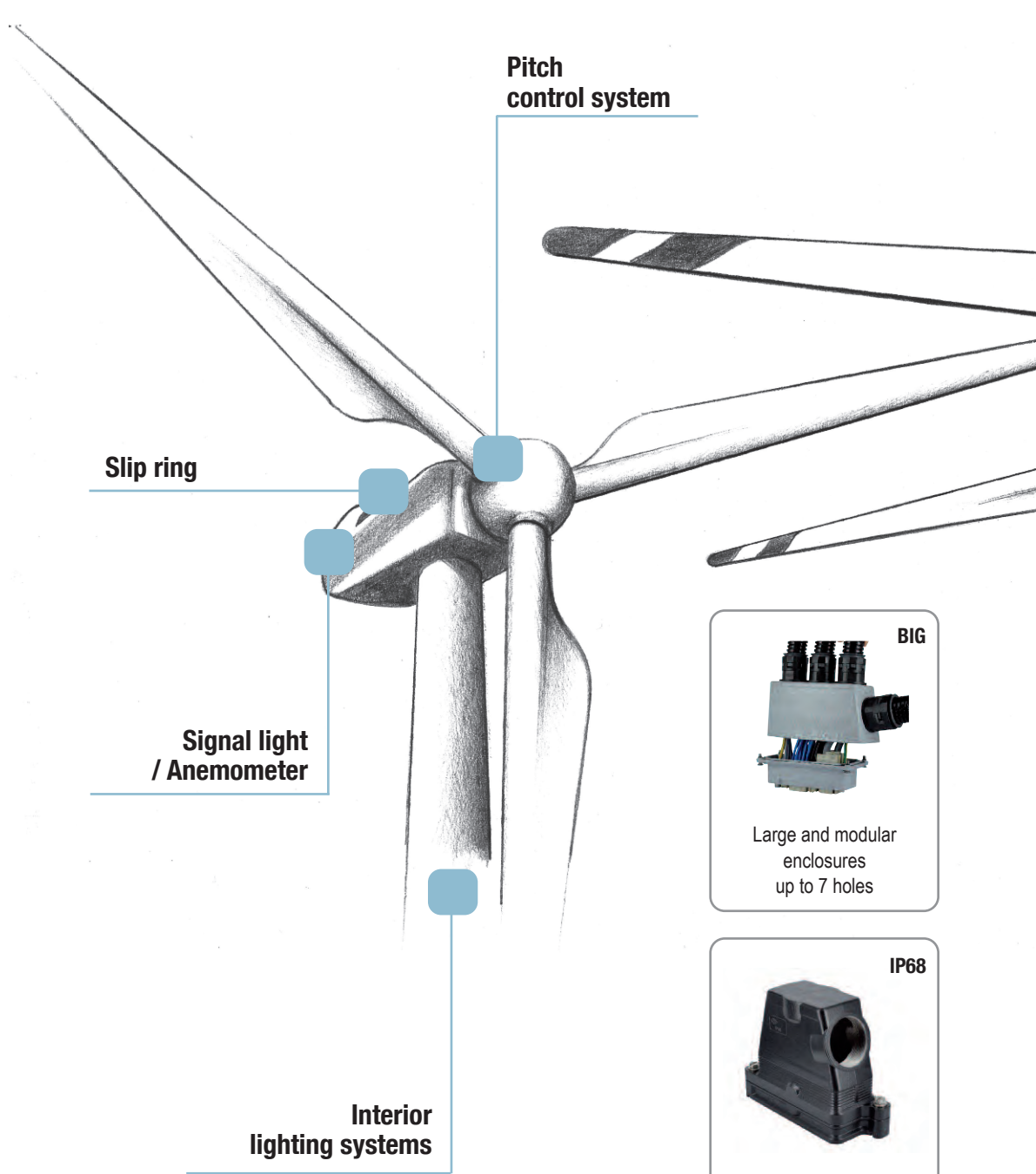

CK



Metal or insulating enclosures, up to 12 poles

CQ



Insulating, up to 40A inserts

IP68



Up to IP68 degree of protection

C-TYPE



Standard enclosures IP65/IP66

T-TYPE



Insulating, over 1000 hrs in salt spray test. Indicated for off-shore installations

W-TYPE



For aggressive environments, Viton® gasket

V-TYPE IP67



For IP66/IP67 degree of protection, vertical closing

EMC



Provided with conductive gasket and treated surfaces

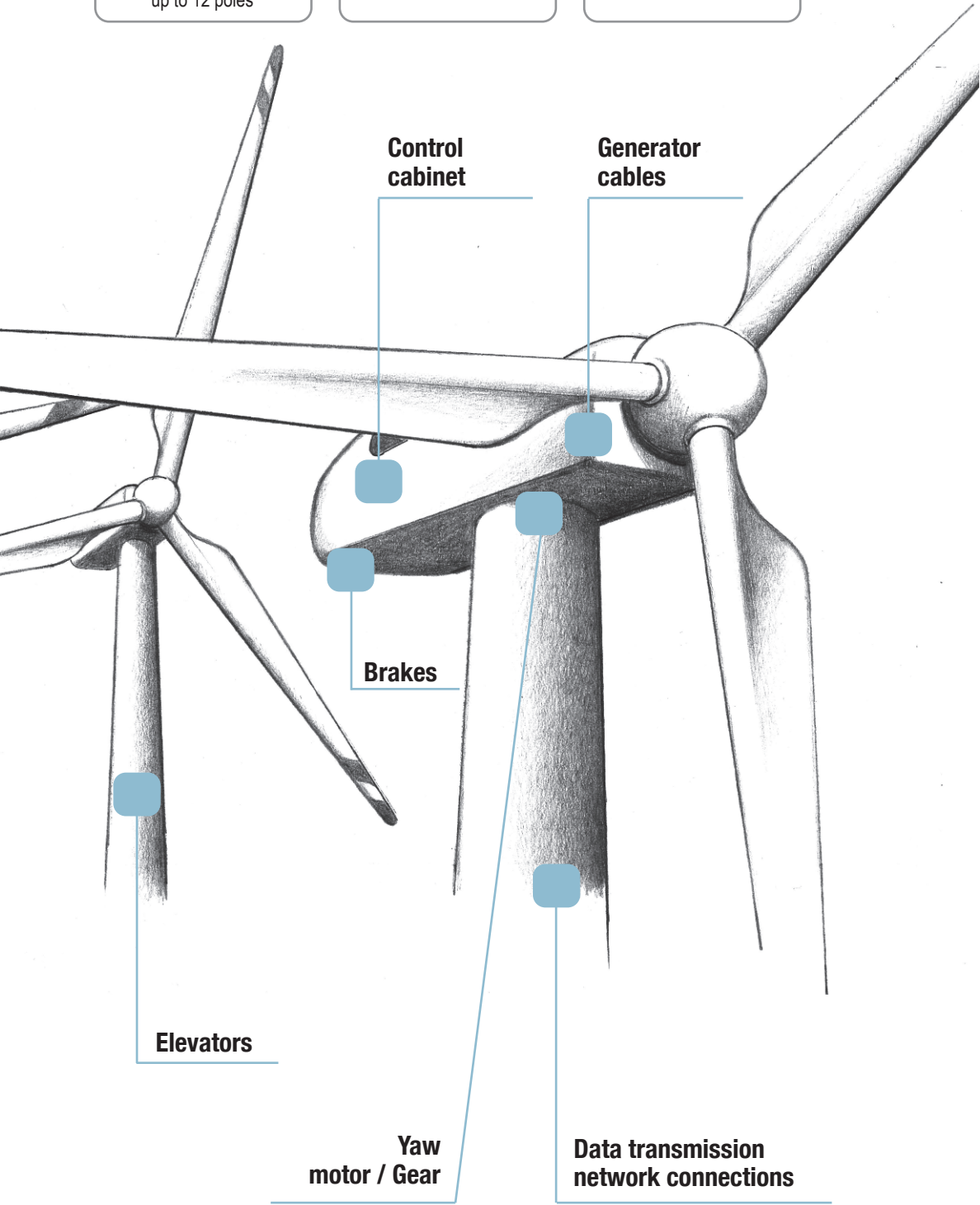

Inserts for multipole connectors

Inserts are made of self-extinguishing thermoplastic resin UL 94 V-0, normally used for applications in a maximum ambience temperature of 125 °C. Different conductor connection techniques are available: screw, crimp or flexible spring. The contacts are in silver or gold plated brass. Inserts are numbered on both sides by laser printing or moulded.

There is a large number of versions of inserts selected on the basis of the rated voltage (from 50V to 5000V), the rated current (from 5A to 200A max), the number of poles, the different load combinations required (power and signal poles within the same insert). Inserts are approved in accordance with the approval marks including UL, CSA, CC, GL and GOST.

CQEE
16A High density
CRIMP Contacts



CX 6/6
16A/100A CRIMP Contacts



CD-CDD
10A CRIMP Contacts

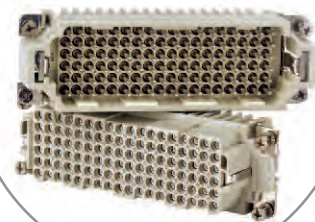

CNE
SCREW Contacts



CSH - SQUICH®
SPRING Contacts with actuator

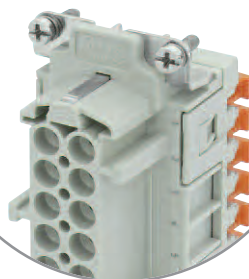

CDS - High Density
SPRING Contacts



CSS
Double SPRING

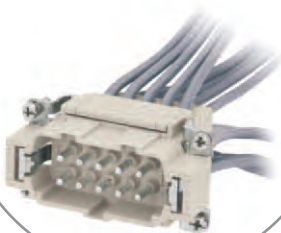

CQ
10A/16A/40A
CRIMP Contacts



CKS
SPRING Contacts



MIXO Inserts for multipole connectors

The MIXO Serie range is a system of modular units for special applications that uses traditional enclosures. Each enclosure can house different types of connections such as: electrical signals and contacts for the conduction of compressed air and liquids with pressure values up to 8 bar, fibre optic connectors, connectors for Ethernet networks, USB and coaxial connectors.

The insert compartments are made up by installing several modules next to one another in order to form a single compact block that is then mounted on metal frames with mandatory housings. Once the modules have inserted and locked with the special tabs, the connector can be inserted into the enclosure.

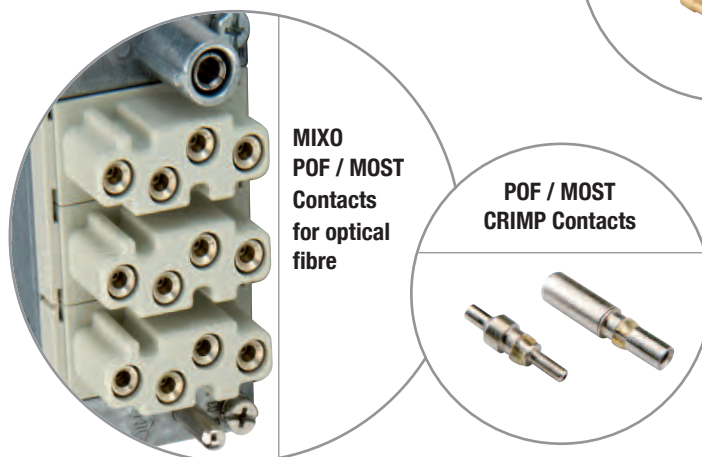
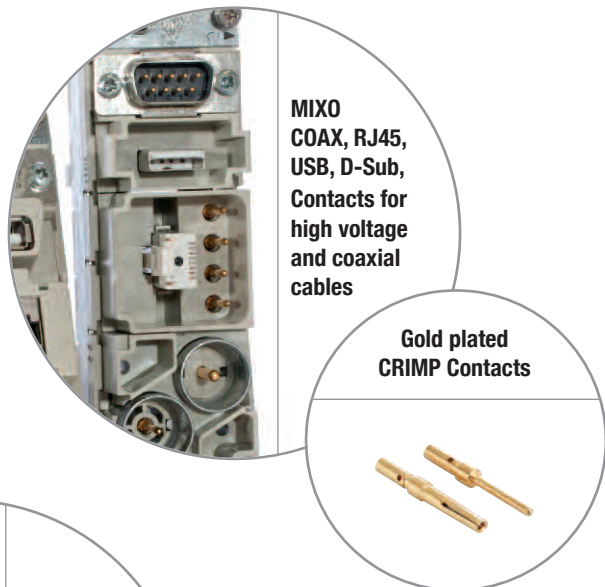
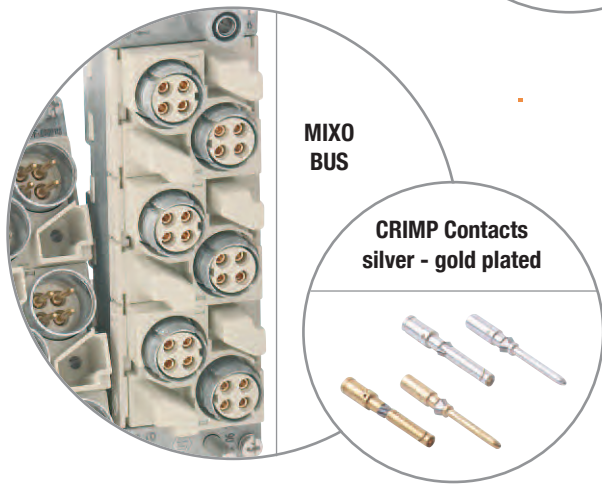
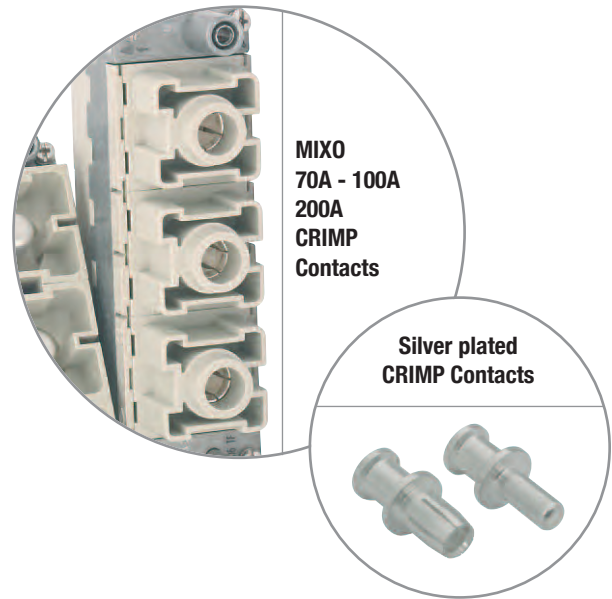
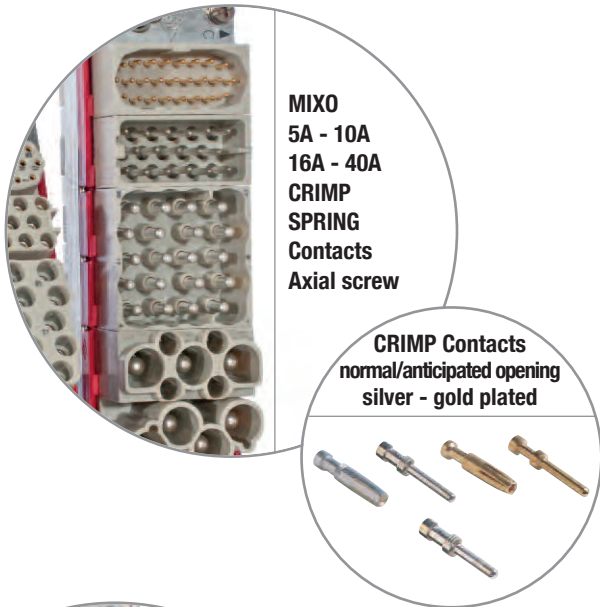

Enclosures for multipole connectors

T-TYPE >

Alongside the wide range of traditional metallic enclosures for ILME multipole connectors, there is now available a **new series of enclosures in self-extinguishing** thermoplastic material in the most common sizes ("44.27", "57.27", "77.27" and "104.27"). **Quality and low cost** are the main features of these enclosures, as an outcome of careful product studies. Valuable characteristics of these new enclosures:

- **significant structural solidity** and mechanical robustness by virtue of **substantial thickness**;
- **resistance to the main chemical agents**, found in industrial environments;
- **pre-fastened gaskets** for easier installation;
- **external dimensions** of the bulkhead housing are **similar to those of the corresponding metal enclosures**; **hole fixing centres are unchanged**.
- **ample space** inside enclosures for cables, with mounted connectors, similar to the corresponding metal high construction versions;
- possibility of making completely **insulated constructions** (equivalent to Class II);
- **absence of powder paint** for environments in which these are not recommended;
- **non-electrostatic** thermoplastic material.
- manufactured from **insulating material, do not require special reinforced insulation as the metal versions do**, for use with series CME higher voltage connector inserts (screw-type terminals);
- protection rating for coupled connectors is **IP65** according to norm **IEC/EN 60529**;
- **UL Type 12** (= NEMA 12) degree of protection according to American standards **ANSI/UL 50** for indoor use;
- each enclosure carries its own part number and conformity markings;
- ambient temperature range: -40 °C / +90 °C.



< IP68

The hoods with IP68 protection rating are particularly suitable for any application requiring high resistance to pressure, impact and corrosion.

They also ensure a good screening for electromagnetic compatibility, resistance to vibrations in compliance with EN 61373 standard and to pressurised water.



> Screw locking



> Bayonet locking

BIG >

Large modular enclosure, more entries and space for cables

The **BIG Serie**, based on the wide-ranging experience achieved by ILME, introduces a significant change in the design of hoods and has been specifically designed to meet the new requirements of the wiring market.

The **large dimensions** of these innovative enclosures have been chosen to offer customers an adequate space to store conductors.

The **cable compartment is now fully accessible during assembly** (the connector insert is fully inserted in the lower half of the enclosure). **Offering three time the space compared to standard enclosures.** This means it is possible to bend cables and pipes with greater bending radiuses.

Due to this special feature, the new BIG enclosures are **particularly suitable for MIXO modular inserts**, being versatile and customizable, for multiple cable entries. **Each insert**, that is used to manage power and signal electrical connections, pneumatic, fibre optic or Ethernet connections **has a dedicated entry, in practical terms it is now possible to use one BIG connector enclosure for installations that previously required two.**

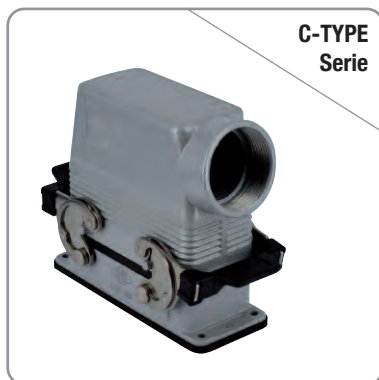
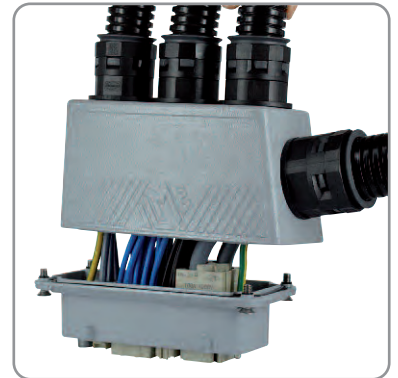

C-TYPE Serie

< STANDARD

A large number of enclosure versions are available with different combinations of component materials, each one suitable to a specific installation: normal environmental conditions, high temperature environments, aggressive environments and environments that require electromagnetic compatibility. The coupling stability and protection against accidental opening are assured by single or double closing devices comprising levers, springs and pegs in stainless steel or entirely in plastic (CK and MK series). Sealing is assured by special gaskets that protect the contact groups inside the enclosures against dust and aggressive agents.

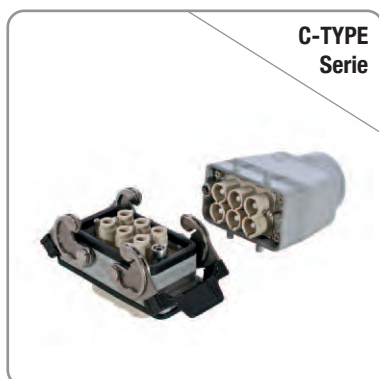

C-TYPE Serie



CK Serie



CQ 08 Serie

AGGRESSIVE ENVIRONMENTS ›

The Heavy Duty Serie is specifically **designed for industrial applications where particularly aggressive external** agents are present (in example: salty environments, etc.). The series is available in 10 different sized enclosure ranges. Housings are available in bulkhead or surface mounting. Hoods are available with side or top entry.

The new series, **easily identified because of its black finish**, offers the following features:

- innovative **chromium-plating treatment applied to the die-cast elements** (pursuant to RoHS) that has **improved resistance by 50% during salt spray tests** (carried out in accordance with UNI EN ISO 9227 standards) as compared to the previous versions with green finish;
- **stoved paint finish with epoxy powder (which provides a greater resistance to chemical agents as compared to epoxypolyester).**



◀ EMC ENCLOSURES

The EMC Enclosure's surfaces are treated to make them extremely conductive while maintaining the necessary corrosion resistance. The bulkhead mounting housing has a special conductive gasket. For best results the surface underneath the gasket should be conductive. Since the use of this enclosure system presupposes the use of shielded cables, the hood should comprise a special cable gland with anchoring device for the cable shield. These metal cable glands ensure IP66 protection rating, are resistant to corrosion and equipped internally with a contact element with geometry that ensures uniform earthing of the cable conductor shield on the metal shell of the hood.

V-TYPE IP67 ›

Due to the vertical closing movement, the new lever offers an IP66/IP67 protection (according to EN 60529) when fitted with a complete and coupled connector and used **with ILME standard hoods in die cast aluminum with pegs (without adaptor). The tight seal after closure and the simplicity of the movement are the key characteristics that only ILME has managed to combine into a single lever.** The V-Type lever also has other interesting functional characteristics for several applications:

- **the friction on the pin is almost zero** because the lever exerts its pressure vertically, thus significantly reducing wear in case of frequent use;
- **the complete lever is manufactured in stainless steel** and is fitted with a catch that prevents it from being accidentally detached;
- **the absence of parts in plastic** offers a higher resistance to impacts and in case of contact with oils and aggressive chemical substances or high ambient temperatures;
- **the lever can be used for applications with vibrations** because it has no springs and is therefore more rigid;
- **the lever occupies a very small space during the closing phase;**
- **it is recommended in cases in which the weight of the cable tends to open elastic levers**, like those with vertically installed connectors and cable exits in the bottom.

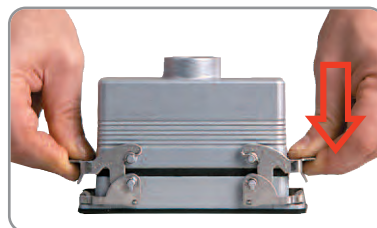

› Closing phase

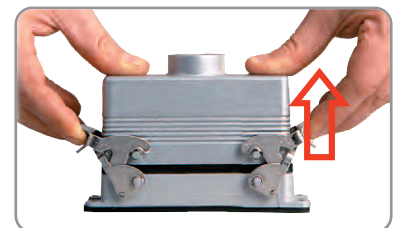

› Opening phase

Accessories for multipole connectors

COB SYSTEM >

The COB System allows to use multipole connectors within electric panels without the traditional metallic housing, as protection is assured by the electric panel itself or other boxes. The COB system may be assembled in the three following ways:

- on panels by the window snap fastening device;
- on DIN EN 60715 rails, both lengthways and crossways to the support;
- on fixed panels by using screws.

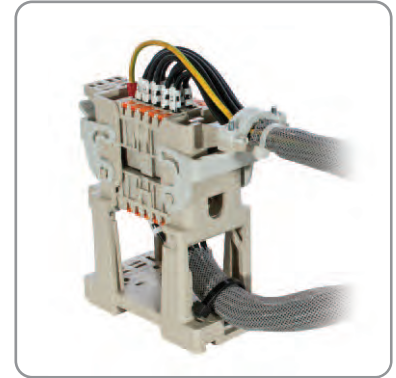

< DOCKING FRAME

Suitable for all connector inserts and frames.

Designed to be used in all industrial applications that require, during assembly or maintenance, the connection of connectors with out possibility of controlling the alignment. Enables the self-centring "blind" coupling of two corresponding connectors without the use of enclosures.



FIBRE OPTIC SC CONTACTS >

The new adaptor **CLK 04 SC** enables use of **fibre optic SC contacts**, up to 4 SC contacts per connector, for indoor or outdoor heavy duty industrial applications, with ILME connector enclosures size "21.21" series **CKA** (IP66/IP67, metallic, both C-Type, grey-painted, for normal environments, and W-TYPE black-painted, for aggressive environments, only the hood models provided with sealing gasket), series **CGK/MGK** (IP66/IP68, metallic, either Pg or metric-threaded cable outlet) and series **CK** (IP66/IP67, insulating, only the hood models provided with sealing gasket).

The fibre optic SC contacts (genderless, to be purchased separately) are available both for multi-mode fibres (50/125 µm or 62,5/125 µm) and single-mode fibre (9/125 µm). The fibre optic SC contacts are also available for the hard-clad silica (HCS) or polymer-clad fibre (PCF) 200/230 µm fibre optic cables and for the less demanding, with shorter transmission distance covered, but more cost effective POF Ø 1 mm applications, available with crimp technique version (crimping tool required).



CR...SP/SS/FS ANCHORS >

The CR...FS Serie of anchorages is designed for use with connector inserts (normal or MIXO modular) without enclosures and enable securing cables with clamps to prevent transmitting friction forces to contacts.

CR...SS anchorages (with grip to facilitate detachment) are used for earth connecting several conductors and/or for the screen of shielded cables.

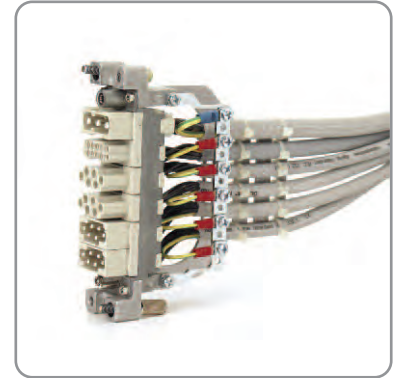

< CX 1/2 BD INSERT ADAPTOR

The new CX 1/2 BD Insert Adaptor allows to use round shielded connectors series MIXO BUS (multiaxial, for balanced cables with multiple pairs) or coaxial connectors (for coaxial cables) even in compact enclosures size "21.21" **CKA/MKA or CGK/MGK**.

This insert can be used to assemble MIXO coaxial connectors part no. **CX 01 BM/BF** for coaxial cables with a typical impedance of 75 Ω and **CX 01 BCM/BCF** for coaxial cables with a typical impedance of 50 Ω , or **MIXO BUS CX 04 BM/BF** multiaxial shielded connectors with 4 poles + shield and the new **CX 08 BM/BF** shielded connectors with 8 poles + shield, providing **seats for 2 additional optional contacts** series CD for the connection of a SELV (very low safety voltage) supply line.

CR SC / AT / ST SHIELDED CONNECTORS >

The CR SC / AT / ST Shielded Connectors have their shield insulated from the enclosure's earthing point. If you wish to earth-connect the shield, install on the panel an anchorage for shielded cables CR...ST or the CR GND metal adaptor.

Anchorage CR...AT/ATD are designed for installation on the frames of the MIXO modular connectors for earth connecting several cables.

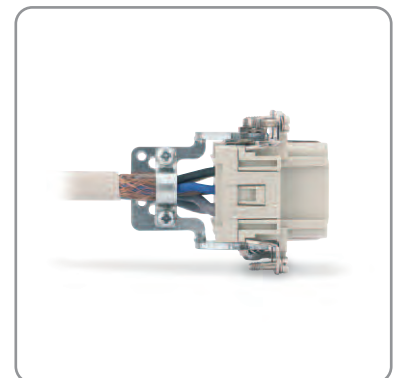

< RJ45 CONNECTORS

RJ45 connectors are available both in modular versions and for enclosures series CK-CKA in Ethernet Category 5 and Category 6A.

CK - CKS

Screw terminal connection
10A - 250V
Spring connection
10A - 400V



CD

Crimp connection
10A - 250V
10A - 50V

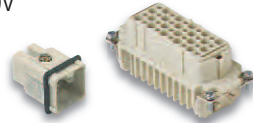

CT - CTS

Screw terminal connection
10A - 250V
Spring connection
10A - 250V



CDD

Crimp connection
10A - 250V



CQ

Crimp connection
10A/16A/40A



CDA - CDC

Screw terminal connection
16A - 250V
Crimp connection
16A - 250V



CQE - CQEE

Crimp connection
16A - 500V



CSH-SQUICH®

Spring connection without tools
16A - 500V



CNE - CSE - CCE

Screw terminal connection
16A - 500V
Spring connection
16A - 500V
Crimp connection
16A - 500V



CDS

Spring connection
10A - 400V



CSS

Spring connection
16A - 500V
Dual terminal



CT - CTSE

Screw terminal connection
16A - 400V/500V
Spring connection



C-TYPE

- Metallic
- CLASS rotative lever
- IP65/IP66



V-TYPE IP67

- Metallic
- Water tightness in a limited space
- Stainless steel lever
- IP66/IP67



V-TYPE IP65/IP66

- Metallic
- Water tightness in a limited space
- Stainless steel lever
- IP65/IP66



T-TYPE

- Insulating
- Robust
- Resistant to chemical agents
- IP65



JEI®

- Metallic
- Lever in galvanised steel
- IP66



BIG - HOODS

- Large and modular
- Multiple cable entries
- Simple and easy to inspect cabling
- Electronic card slots
- IP66



CMCE - CME - CMSE

Crimp connection
16A - 830V
Screw terminal connection
16A - 830V
Spring connection
16A - 830V



CP

Screw terminal connection
35A - 400V/690V



CX - MIXED INSERTS

Crimp connection
10A/16A/40A



CX

Screw terminal connection
16A/80A



MIXO

Crimp connection
200A/100A/70A/40A/16A/10A/5A

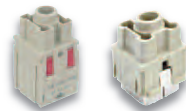

MIXO

Screw terminal connection
40A



MIXO

Spring connection
16A

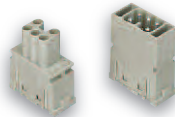

MIXO

Data
RJ45-USB-POF-BUS-COAX



MIXO

Pneumatic

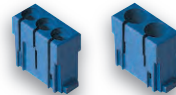

DESINA

Crimp connection



COB

- Mounting inside control panel
- Inspectable
- IP20

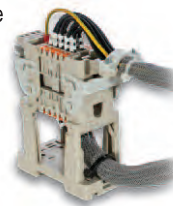

PANEL-MOUNTING



W-TYPE

- Metallic with chrome treatment
- For aggressive environments
- IP66



EMC

- For electromagnetic compatibility
- Conductive gaskets
- IP66



180 °C

- Metallic
- For high temperature environments
- IP65



CENTRAL LEVER

- For limited mounting spaces
- Reduces insert uncoupling stress
- IP65



IP68

- Water tight
- Mechanical robustness
- Resistant to chemical agents
- Screw or bayonet locking
- IP68



830V

- Insulated for CME and CMCE
- 16 poles inserts
- CLASS lever
- IP65/IP66



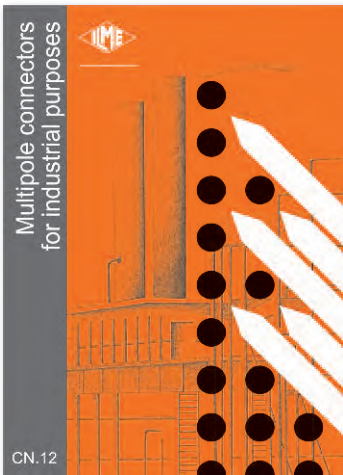

CN12
Multipole connectors

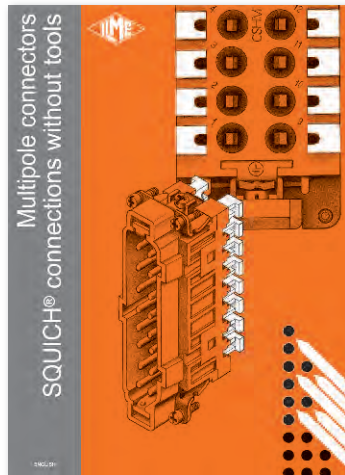

CSH-SQUICH®
Connection without tools

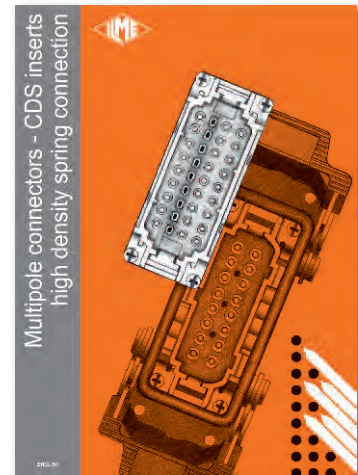

CDS
High density spring connection

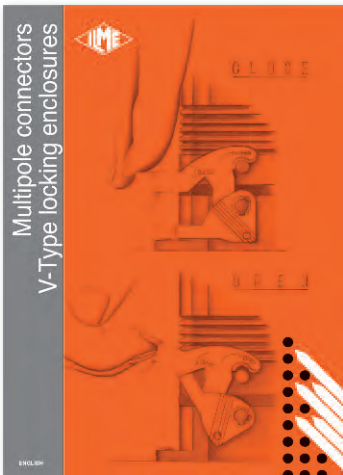

V-TYPE IP67 ENCLOSURES
V-Type locking enclosures

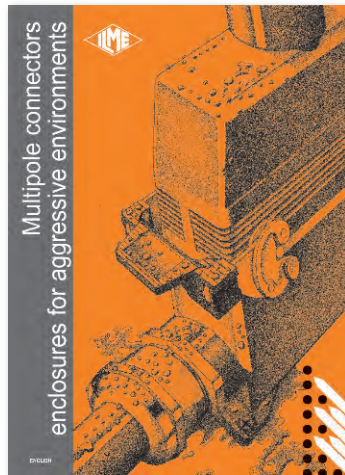

CW ENCLOSURES
For aggressive environments



BIG HOODS
The space you have always wanted



IL-BRID ENCLOSURES & CDA Inserts

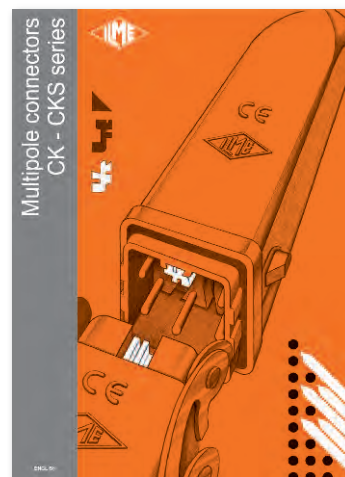

CK-CKS ENCLOSURES
With code pins

**I.L.M.E. SpA**

via Marco Antonio Colonna, 9
20149 Milano - Italy
☎ +39 02 345605.1 - fax +39 02 316330
www.ilme.com

ILME FRANCE S.A.R.L.

Rue Roland Garros - B.P. 125
Parc d'Activités de l'Aéroport
42163 Andrézieux - Bouthéon (France)
☎ +33 (0)477 362 336 - fax +33 (0)477 369 797
e-mail: ilme-france@ilme.fr - www.ilme.fr

ILME GmbH

Max-Planck-Straße 12 - 51674 Wiehl (Germany)
☎ +49 (0)2261 - 7955-0
fax +49 (0)2261 - 7955-5 (Auftragsannahme), +49 (0)2261 - 7955-9 (Vertrieb)
e-mail: technik@ilme.de - www.ilme.de

ILME UK LIMITED

50 Evans Road, Venture Point
Speke Merseyside L24 9PB (United Kingdom)
☎ +44 (0)151 3369321 - fax +44 (0)151 3369326
e-mail: sales@ilmeuk.co.uk - www.ilmeuk.co.uk

ILME NORDIC AB

Transportvägen 18
24642 Löddeköpinge (Sweden)
☎ +46 46 18 28 00 - fax +46 46 18 28 10
e-mail: info@ilme.se - www.ilme.se

ILME JAPAN CO., LTD.

Kobe International Business Center 511
650-0047, 5-2, 5 - Chome,
Minatojima Minami-Machi - Chuo-Ku, Kobe (Japan)
☎ +81 78 302 2005 - fax +81 78 302 2060
www.ilme.jp

ILME CHINA REP. OFFICE

Room 201 Universal Centre,
no.175 XiangYan NanLu,
200031 Shanghai (China)
☎ +86 21 62489961 - fax +86 21 62489961
www.ilmechina.com

Ed.09/2014



XDG EOL 914

8 10 157 47 208659



Catalogues